

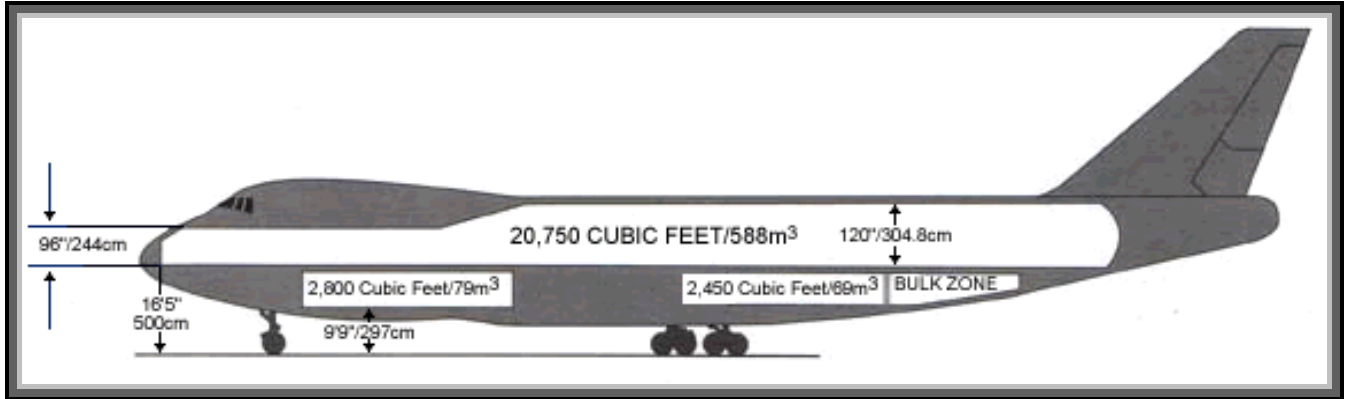

B 747-200F ND

CARGO LOADING & INTERIOUR SPECIFICATIONS

1. AIRCRAFT GENERAL SPECIFICATIONS



Aircraft Type	: B747-281 F
Maximum Takeoff Weight	: 378.000 Kgs
Maximum Landing Weight	: 285.766 Kgs
Cruising Speed	: 925 KM/H
Maximum Payload Range	: 5.712 NM
Maximum Gross Payload	: 110.000Kgs
Main Deck ULD Configuration	: 29 Pallets (96"x125")
Main Deck Volume	: 588 m ³
Lower Deck Fwd ULD Config.	: 5 Pallets (96"x125")
Lower Deck Fwd Volume	: 79 m ³
Lower Deck Aft ULD Config.	: 4 Pallets (96"x125")
Lower Deck Aft Volume	: 69 m ³
Bulk Volume	: 22,5 m ³
Total Available Load Space	: 758,5 m ³

2. LOADING CONFIGURATION - WITH 29 M / D PALLETS

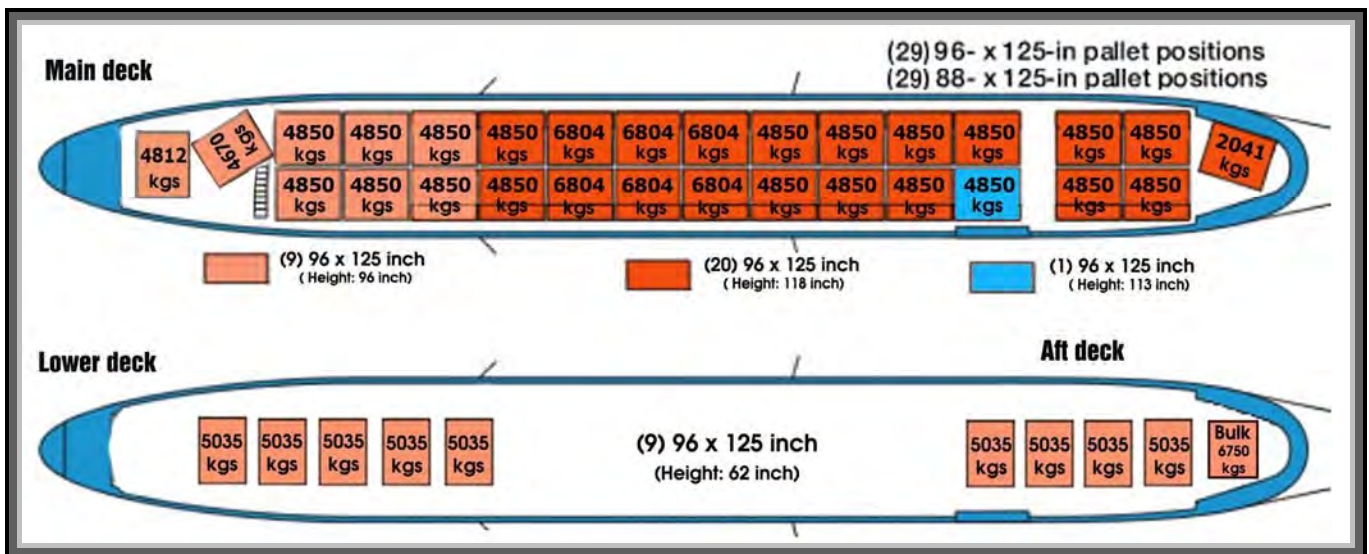



3. LOADING DOORS

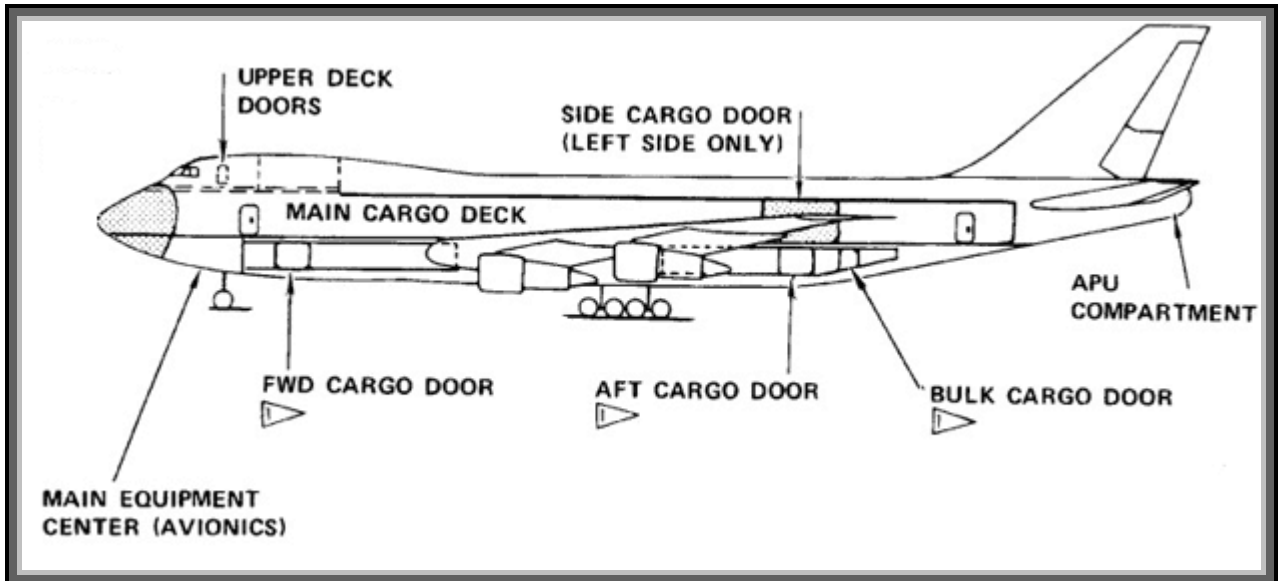

4. DOOR DIMENSIONS

NOSE DOOR

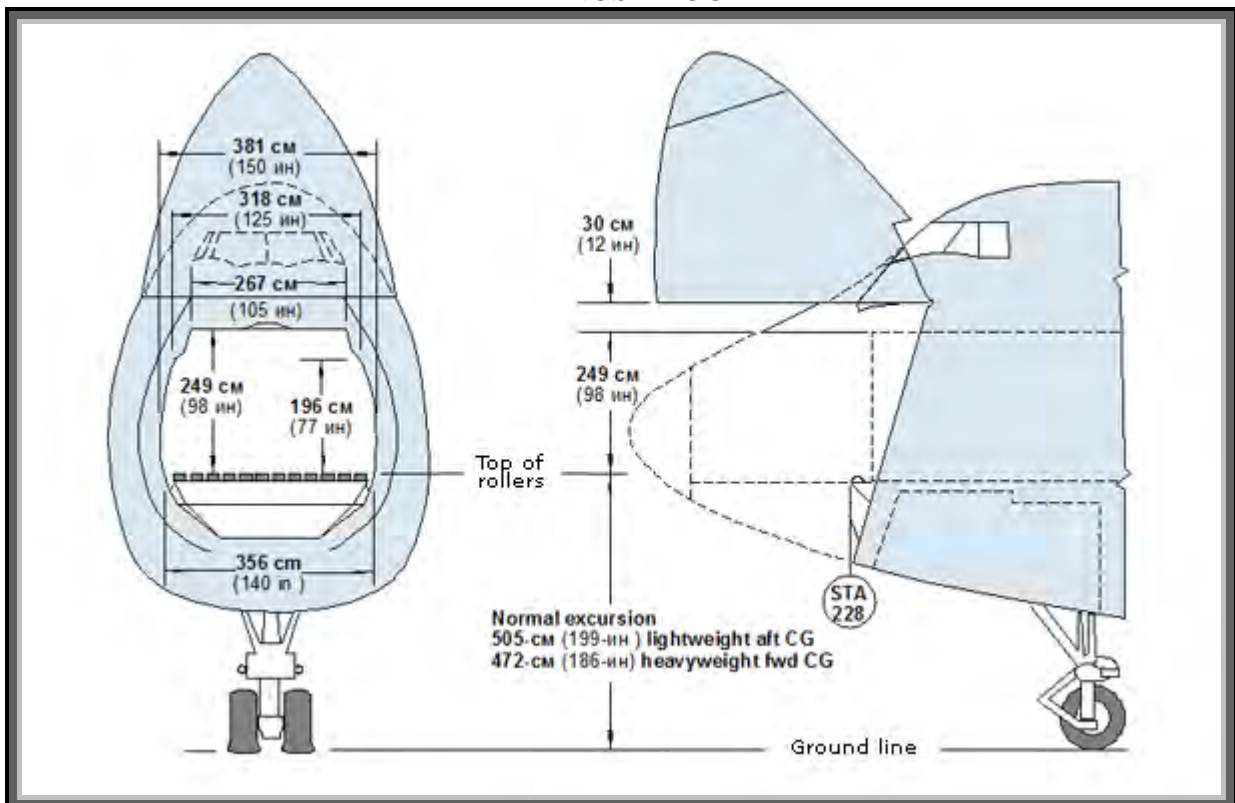



MAIN DECK SIDE DOOR

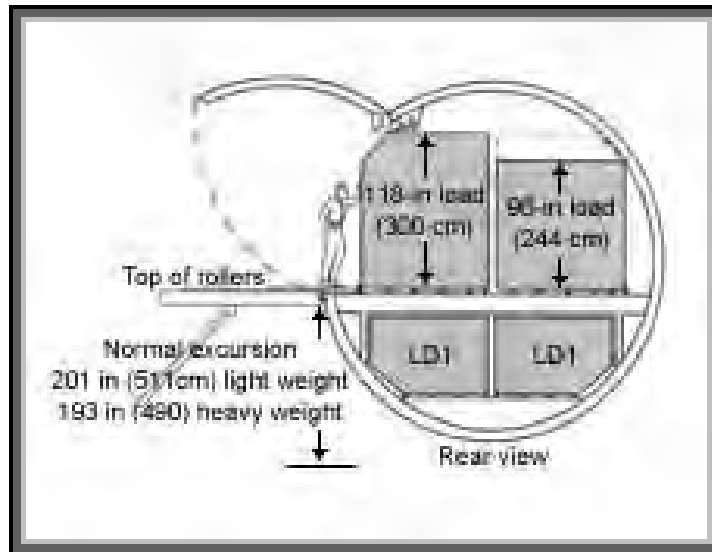

Dimensions	Width	Height	Width	Height
Main Deck Side Door	340 cm	312 cm	134 inc	120 inc
Lwr Fwd	264 cm	168 cm	104 inc	66 inc
Lwr Aft	264 cm	168 cm	104 inc	66 inc
Bulk	112 cm	119 cm	44 inc	47 inc

5. PALLETS





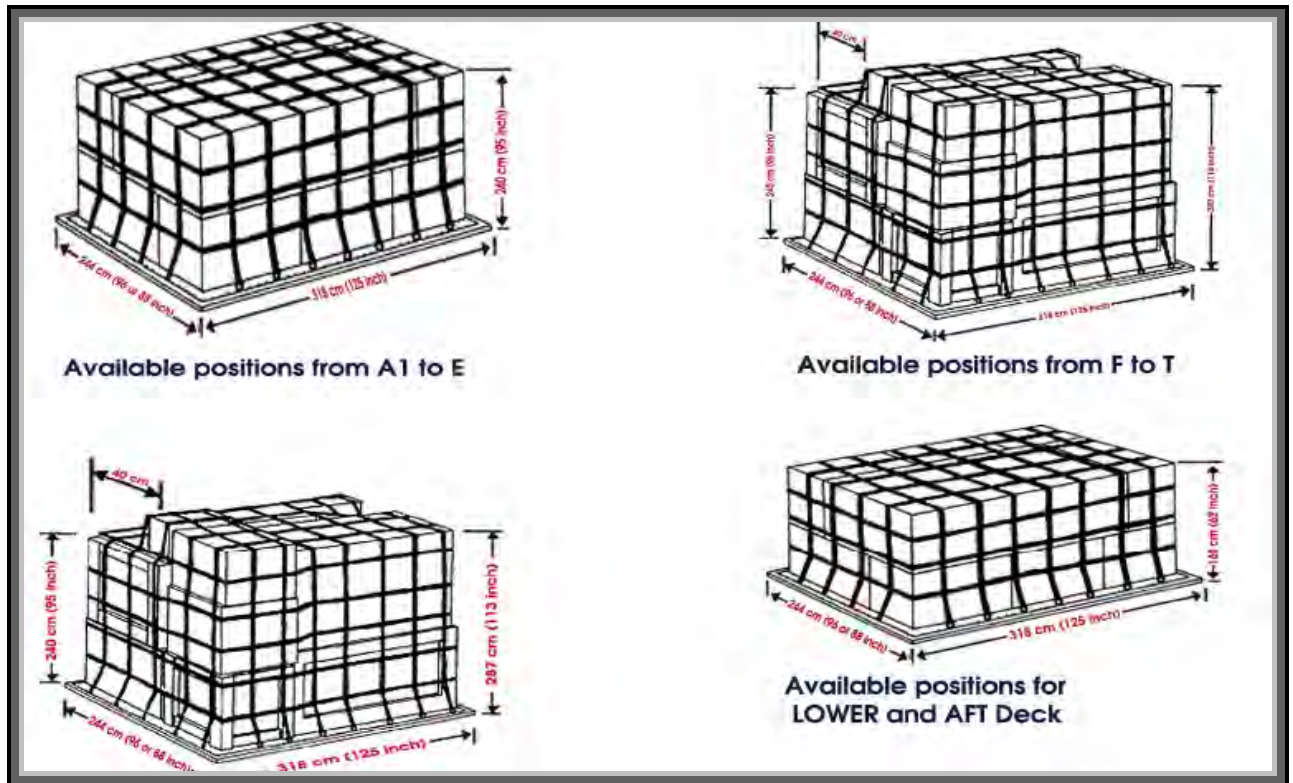

6. PALLET LOADING DETAILS

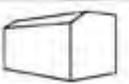
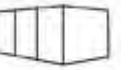

B747-200s

	International Pallet Designation Code	Max External Dimensions L x W x H [IN./CM.]	Internal Cubic Capacity [CU. FT/M ³]	Maximum Gross Weight LCS./KB.	Weight Tare LBS. [approx.] LBS./KG.
	2H M-1H	125" x 96" x 118" 317 x 244 x 300 CM	772 CU. FT. 21.9 M ³	15,000 LBS. 6,818 KG.	255 LBS. 116KG.
	2 M-1	125" x 96" x 96" 317 x 244 x 244 CM	640 CU. FT. 18.1 M ³	15,000 LBS. 6,818 KG.	255 LBS. 116 KG.
	2 M-2	238.5" x 96" x 96" 606 x 244 x 244 CM	1,250 CU. FT. 35.4 M ³	25,000 LBS. 11,340 KG.	1,000 LBS. 454 KG.
	5 2BG	125" x 96" x 64" 317 x 244 x 163 CM	440 CU. FT. 21.9 M ³	11,100 LBS. 5,035 KG.	255 LBS. 116 KG.